

imagePROGRAF
TM-5350 | TM-5355

Canon
Delighting You Always

Just Perfect.

Endless Productivity Made Swift

36"

5
colour
pigment ink



TM-5350



TM-5355

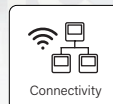
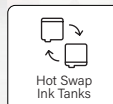
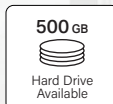

The all-new 36" **imagePROGRAF TM-5355** and **TM-5350** large format printers empower every print delivery with enhanced scanning operability and printer processing power, delivering high quality CAD drawings, photos and posters. Redefine your workplace productivity with a seamless, swift and reliable print partner.

Printing Productivity Driven By Swift Efficiency

Push printing productivity forward with the all-new 36" **imagePROGRAF TM-5355** and **TM-5350** large format printers, which offer powerful scanning and printing capabilities, alongside versatile multi-application printing for engineering firms to drive greater business efficiency overall.

Swift and Productive

The new **L-COA PRO II high-speed imaging processing chip** facilitates swift startups from sleep mode as well as continuous printing by providing improved data processing power, improving overall printing efficiency.

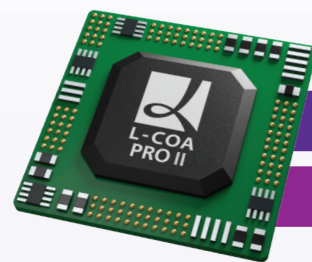

Print Speed

Conventional printers →

TM-5350/TM-5355 →

More than 20% faster*

*Based on Canon internal testing using plain paper with continuous printing of A1 page per min

Enhancing Prints with Vivid Red

The **brand new magenta ink** offers a more vivid red on CAD drawings, posters and photos that help to improve clarity and details.



Borderless Printing Made Easy

Borderless poster printing on any size of roll paper is possible with the TM-5350 and TM-5355.

Making User Operation Easy

The new design of the printer features a **flat top space** for roll paper replacement or for placing output prints.

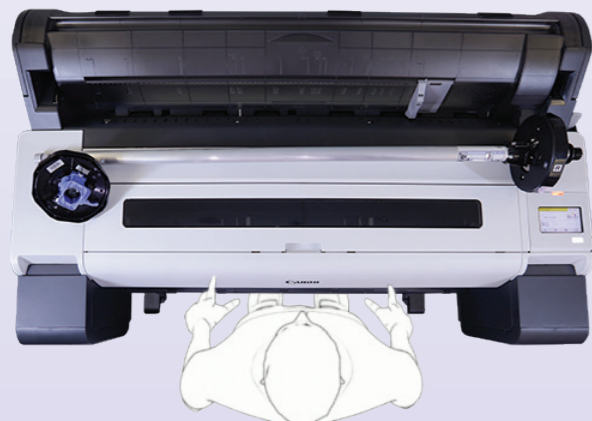

The **automatic paper type detection** allows for easy viewing of paper media details and the balance of roll paper within the printer.

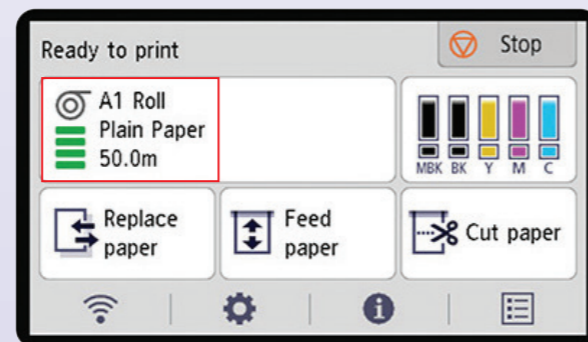

Smoother, Easier Workflows

Streamline how you manage workflows with convenient and intuitive software applications.

Direct Print Plus

The Direct Print Plus feature allows you to **print PDF or JPEG files in batches** with custom templates with minimal effort.

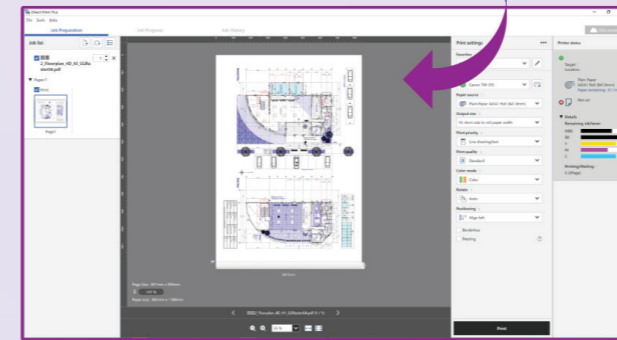

Free Layout Plus

Documents can be resized easily with Free Layout Plus, which allows files to be dragged and dropped into the software for **easy document resizing to specific paper layouts**.

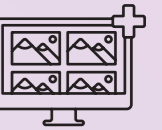

Accounting Manager

Monitor and **keep track of print usage** with ease using the Accounting Manager application.



PosterArtist

Design vibrant posters for your needs with minimal effort using the PosterArtist application.



Check it out at <https://posterartist.canon>



Scanning with Efficiency

The **Lm36 scanner** can be used with the TM-5350, which comes with improved scanning functions that boost productivity and operability through a **maximum paper thickness of 0.8mm** alongside featuring **brand new transparent guides**.

The **TM-5355** is able to utilise the **Z36 scanner** which offers easier troubleshooting by providing a **web manual link** when a printer error occurs. It also features a roll removal button, alongside effortless information retrieval of the **amount of roll paper remaining** in the printer.

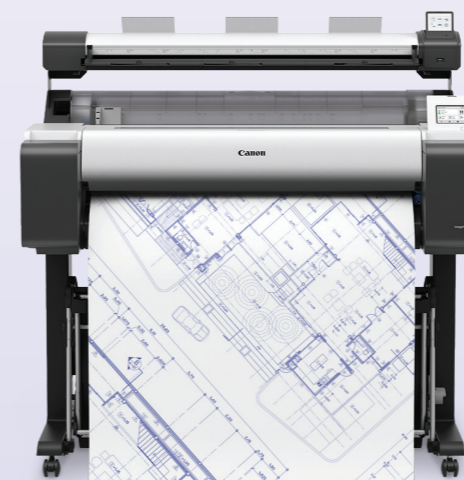

TM-5350 MFP Lm36



TM-5355 MFP Z36

SPECIFICATIONS

PRINTER		TM-5350	TM-5355
Printer Type		5-Colour, 36"	
Number of Nozzles		15,360 nozzles (MBK: 5,120 nozzles, Other Colours: 2,560 nozzles each)	
Max. Print Resolution		2,400 x 1,200 dpi	
Nozzle Pitch		1,200 dpi x 2	
Line Accuracy ¹		± 0.1% or less	
Ink Bottle Size	Sales Ink	130 ml / 300 ml (MBK, BK, C, M, Y)	
	Bundle Starter Ink	130 ml (MBK) / 90 ml (BK, C, M, Y)	
Ink Type		Pigment Ink	
Print Languages		SG Raster (Swift Graphic Raster) HP-GL/2, HP RTL JPEG (Ver. JFIF1.02) CALS G4 ²	
Print Solutions and Applications		- PDF	
Management Solutions		Printer Driver (Win/Mac Versions), Direct Print Plus, Free Layout Plus, PosterArtist Windows/Web & Lite, Wi-Fi Connection Assistant, PIXMA Cloud Link, Apple AirPrint (Mobile), Canon PRINT Inkjet/SELPHY (Mobile), Canon Print System (Mobile), uniFlow Server	
Interface (Built-in)	USB B Port	Hi-Speed USB, Full Speed (12 Mbit/sec), Hi-Speed (480 Mbit/sec), Bulk Transfer, Series B (4 pins)	
	USB A Port	- USB Memory (Direct Print) Supported file format: JPEG/PDF	
	Network	IEEE 802.3 10base-T IEEE 802.3u 100base-TX IEEE 802.3ab 1000base-T IEEE 802.3x Full Duplex SNMP, HTTP, TCP/IP (IPv4/IPv6), FTP	
	Wireless LAN	IEEE802.11 b/g/n WPA-PSK (TKIP/AES) WPA2-PSK (TKIP/AES) WPA3-SAE (AES) WPA-EAP (AES) ³ WPA2-EAP(AES) ³ WPA3-EAP(AES) ³	
Memory Hard Disk		2 GB No Hard Disk	128 GB (Physical Memory 2 GB) 500 GB (Encrypted) Hard Disk
Display		LCD (4.3 inch / 10.9 cm TFT color)	
OS Compatibility	Please visit https://asia.canon to confirm OS compatibility and to download the latest drivers.	Windows, Macintosh	



SOUTH AND SOUTHEAST ASIA REGIONAL HEADQUARTERS
CANON SINGAPORE PTE. LTD.

1 Fusionopolis Place, #14-10 Galaxis, Singapore 138522
 Tel : 65-6799-8888 | Fax : 65-6799-8882 | <https://asia.canon>

Delighting You Always

PRINT SPEED ⁴ (A1 SIZE)		TM-5350	TM-5355
Plain Paper	CAD Drawing (A1 Landscape, Fast Q5 mode)	17 sec	
	CAD Drawing (A0 Portrait, Fast Q5 mode)	32 sec	
Heavyweight Coated Paper	Poster (A0 Portrait, Standard mode)	2 min 33 sec	
MEDIA HANDLING			
Media Width	Roll Paper	203.2 ~ 917 mm	
	Cut Sheet		
Media Thickness	Roll Paper / Cut Sheet	0.07 ~ 0.8 mm	
Printable Media Length	Roll Paper	203.2 mm ~ 18 m ⁵	
	Cut Sheet	279.4 ~ 1,600 mm	
Media Core Size		2 inch / 3 inch core	
Outside Diameter Roll Paper		150 mm or less	
Media Feed	Roll Paper	1 Roll, Top Load, Front Output	
	Cut Sheet	Front Load, Front Output	
Delivery Direction		Face-up, Front Side	
Margins (Top, Bottom, Side)	Recommended Area (Roll Paper)	20 mm, 3 mm, 3 mm	
	Recommended Area (Cut Sheet)	20 mm, 20 mm, 3 mm	
	Printable Area (Roll Paper)	3 mm, 3 mm, 3 mm	
	Printable Area (Roll Paper Borderless Print)	0 mm	
Printable Area (Cut Sheet)		3 mm, 20 mm, 3 mm	
DIMENSIONS (W x D x H) & WEIGHT⁶			
Packaged Dimensions	Printer (Main unit + Stand + Basket + Pallet) (SD-35)	1,462 x 1,122 x 801 mm Weight: 113 kg	
	Printer	1,285 x 748 x 439 mm (Operation panel not tilted up) Weight: 49.5 kg (Excluding print head and ink)	
Printer & Weight	Printer with Stand + Basket (SD-35)	1,285 x 885 x 1,060 mm (Operation panel not tilted up / Basket opened) 1,285 x 756 x 1,060 mm (Operation panel not tilted up / Basket closed) Weight: 63.8kg (Excluding print head and ink)	
Scanner & Weight		1,238 x 253 x 131 mm Weight: 6.56 kg	1,056 x 251 x 156 mm Weight: 7.8 kg System Controller Weight: 2.5 kg
POWER & OPERATING REQUIREMENTS			
Power Supply (Printer)		AC 100-240 V (50 - 60 Hz)	
Power Consumption (Printer)	Operation	< 65 W	< 69 W
	Sleep Mode	< 1.6 W	
	Power OFF	< 0.1 W	
Recommended Environment	Temperature	15 - 30 °C	
	Humidity	10 - 80% RH (no dew condensation)	
Acoustics	Power ⁷	Approx. 6.2 Bels	
	Pressure ⁷	Approx. 41 dB(A), Standby 35 dB(A) or less	
OPTIONAL ACCESSORIES			
Roll Unit		-	
2/3" Roll Holder		RH2-35	
Printer Stand + Basket		-	
Card Reader Interface for uniFLOW		RA-02	
CONSUMABLES			
Ink Tank	Magenta: PFI-8121 (130 ml) / PFI-8321 (300 ml) Matte Black / Black / Cyan / Yellow: PFI-8120 (130 ml) / PFI-8320 (300 ml)		
Print Head	PF-06		
Cutter Blade	CT-08		
Maintenance Cartridge	MC-31		

Specifications are subject to change without notice.

¹ User adjustments required. Printing environment and media must match those used for the adjustments. Paper required: Plain paper and coated paper only.

² USB Thumb drive printing is not supported.

³ IEEE802.1X (EAP-TLS/EAP-TTLS/PEAP) supported.

⁴ Time taken to print one page does not include time required for data processing, data transfer and pre-printing operation.

⁵ Varies according to the OS and application.

⁶ Includes roll holder set.

⁷ Acoustic power and pressure are measured using ISO 7779 standard.

DEALER'S STAMP

This document is for information purposes only. The contents are subject to change without notice. Product options, name and availability may vary by regions. We expressly disclaim any liability or contractual obligations with respect to this document. Brands and product names are trademarks and/or registered trademarks of their respective owners.